

**Hemmers It**  
*fabrics for your creati*

A1

140

128

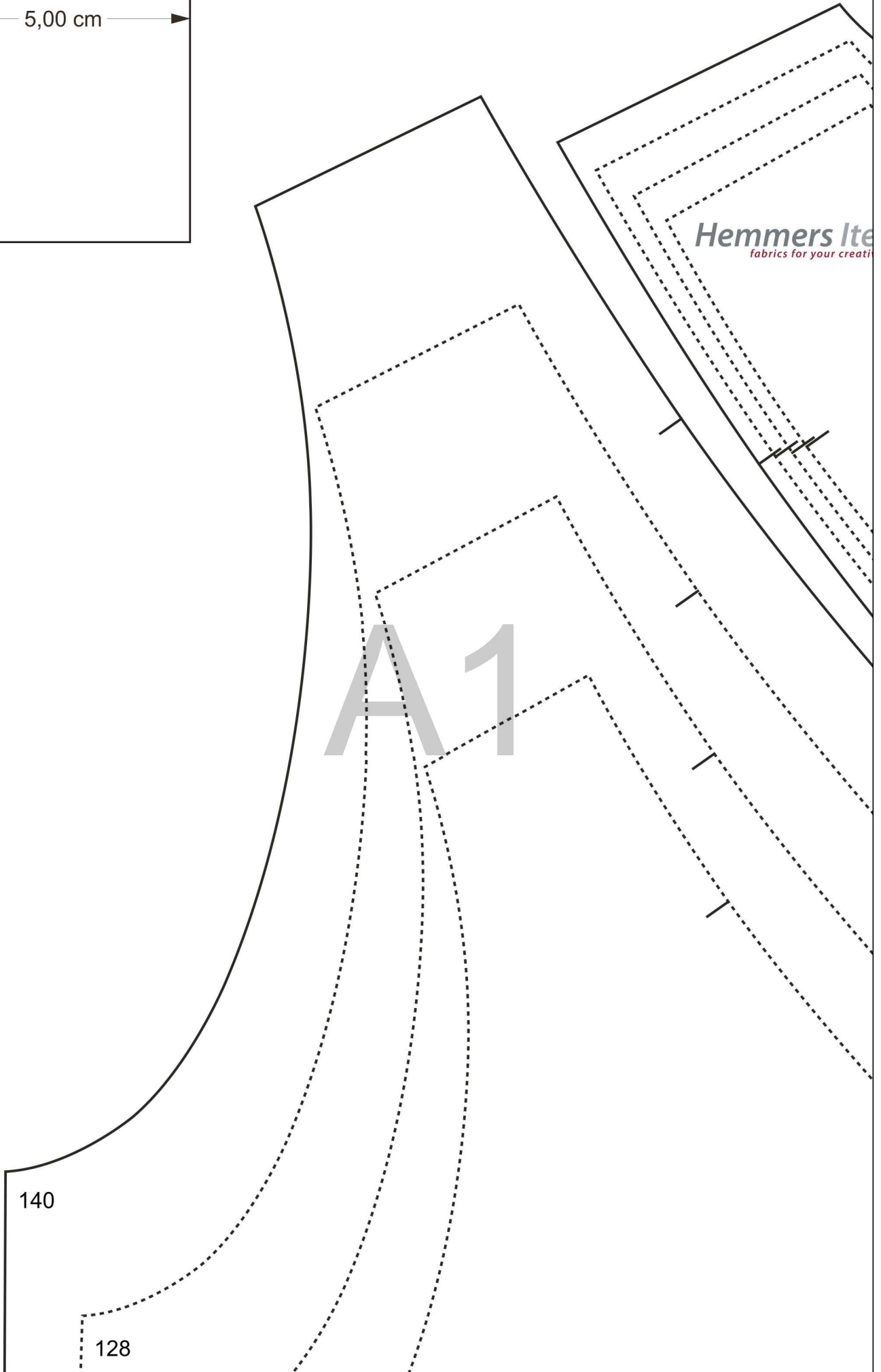

140  
128  
116  
104

MINI & ME

Rückenteil  
2 x

Back  
2 x

Fadenlauf/Straight grain

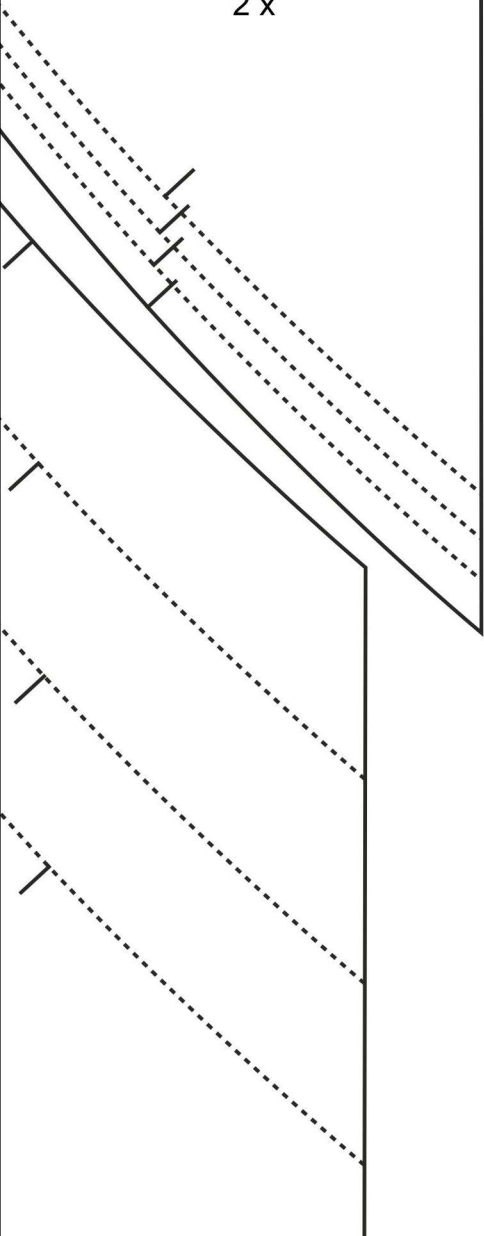

140  
128  
116  
104

Hemmers Itex  
fabrics for your creativity

MINI & ME

Vorderteil  
1 x im Bruch

Front  
1 x cut on fold

Stoffbruch/Fold

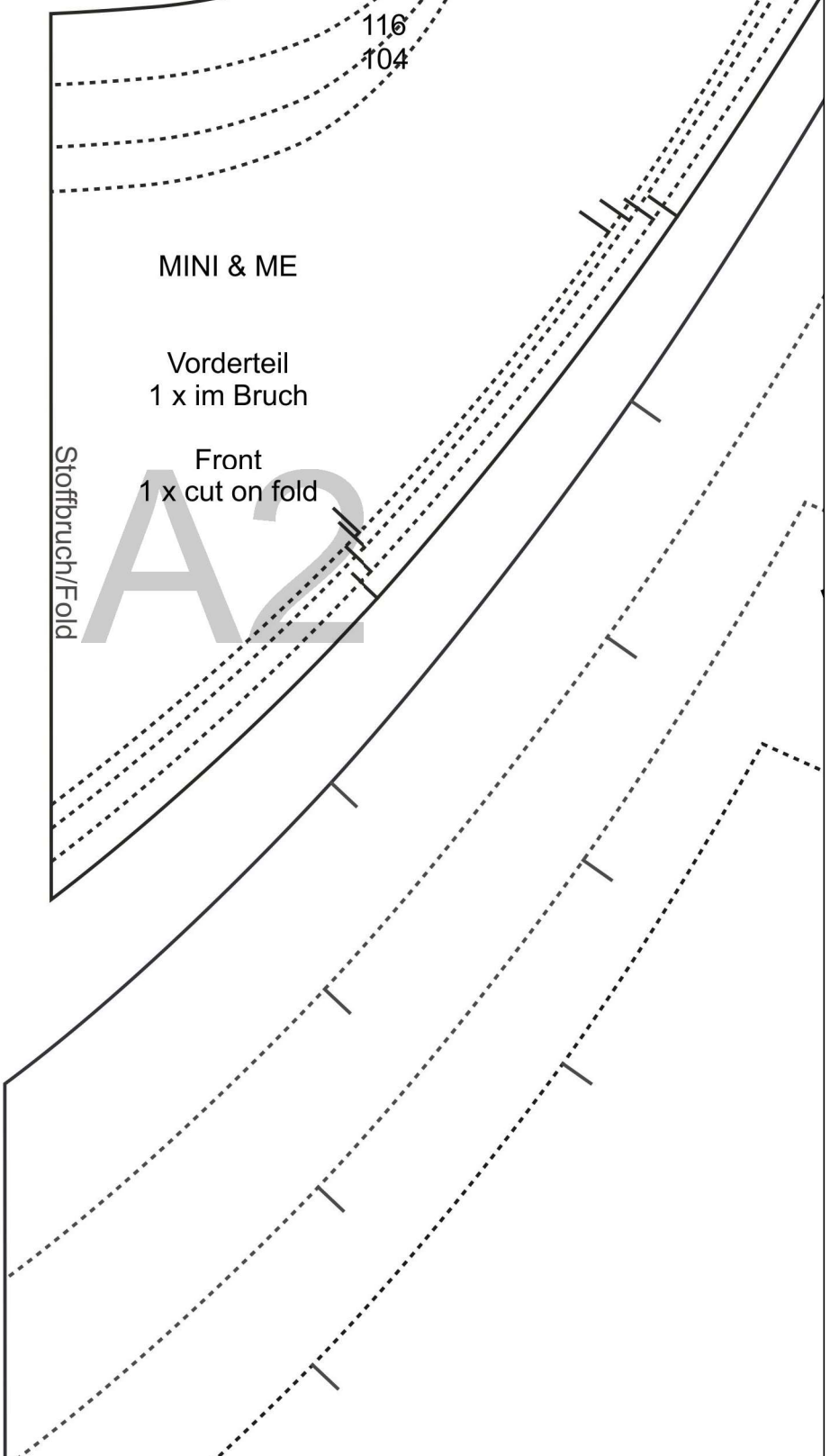

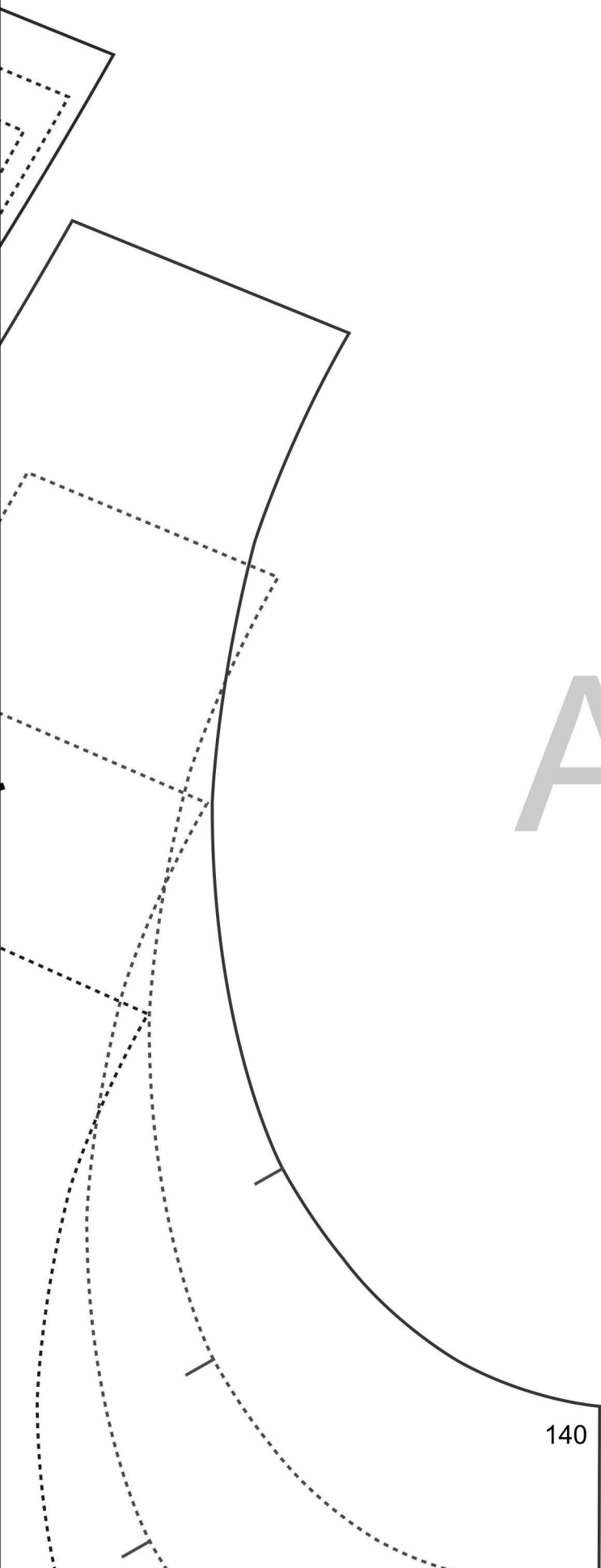

A3

**Hemmers Itex**  
*fabrics for your creativity*

	104	116	128	140
--	-----	-----	-----	-----

<b>Hemmers Itex</b> <small>fabrics for your creativity</small>	104	116	128	140

<b>Hemmers Itex</b> <small>fabrics for your creativity</small>	104	116	128	140

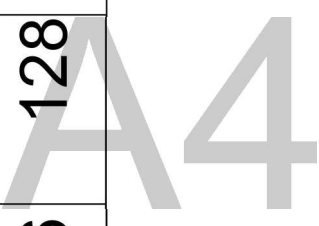



116

104

MINI & ME

Rückenteil  
1 x im Bruch

Back  
1 x cut on fold

B1

Stoffbruch/Fold

Stoffbruch/Fold

B2

MINI & ME

Vorderteil  
1 x im Bruch

Front  
1 x cut on fold

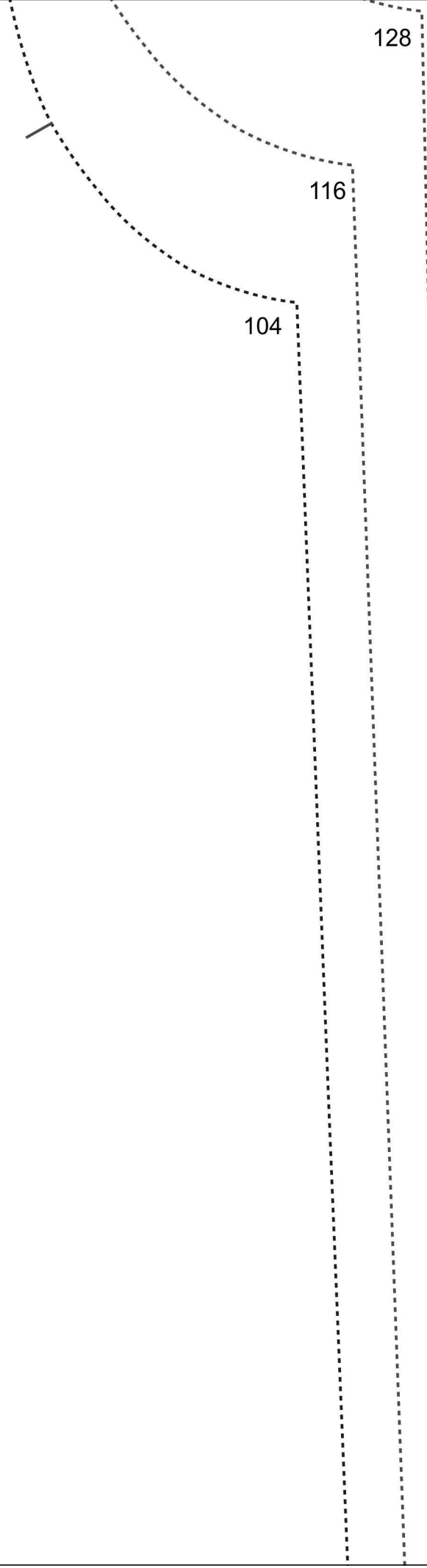

B3

**MINI & ME**

**1 x Volant vorne, inkl. Nahtzugabe**

**1 x Ruffle front, seam allowance incl.**

**MINI & ME**

1 x Volant hinten, inkl. Nahtzugabe

1 ruffle back, seam allowance incl.

**MINI & ME**

x Volantkragen, inkl. Nahtzugabe

ruffle collar, seam allowance incl.



Der Schnitt enthält keine Nahtzugabe.  
Seam allowance not included.

C1

140

128

116

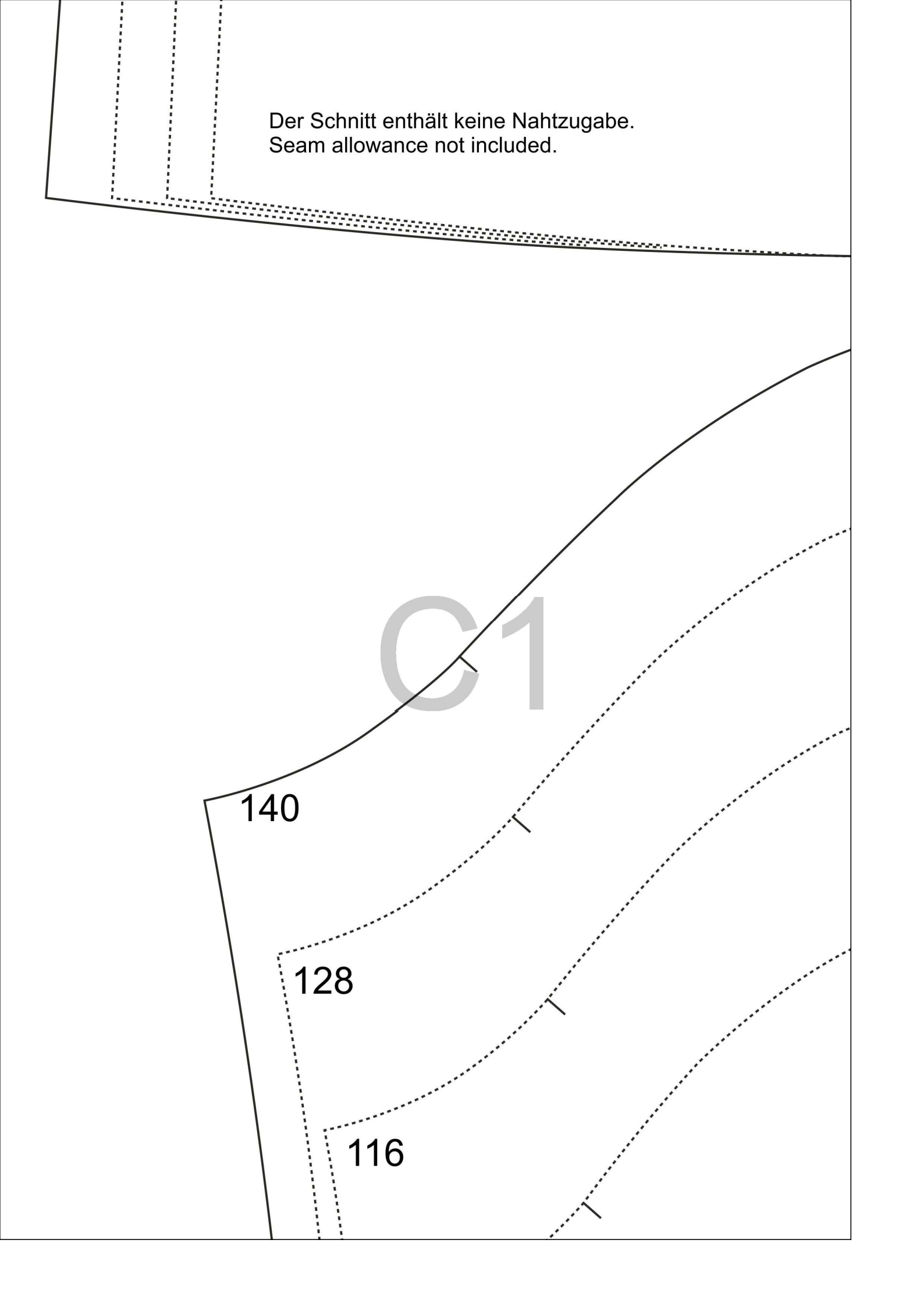

C2



**Hemmers Itex**

*fabrics for your creativity*

C3

C4

1 >

1 x



104

D1

Fadenlauf/Straight grain  
↓

MINI & ME

Ärmel 2 x

Sleeve 2 x

D2

## MINI & ME

2 x Manschette, Nahtzugaben inkl.

2 x cuff, seam allowance incl.

**Hemmers Itex**  
fabrics for your creativity

104116128140